

Control Challenges in Mobile Telecommunications

Mobile telecommunications technology is having an unprecedented impact on human society. Currently, there are more than 4 billion cellular subscribers worldwide; some 2 million new phones are sold each day and 80 billion email messages are sent! Global revenue exceeds \$4 trillion annually. Also, new services are appearing, including TV, web browsing, tethering, and real-time gaming. As in all areas of technology, the successful operation of modern telecommunication systems depends, in part, on highly sophisticated real-time control. The opportunities for advanced control are enormous, but the area poses many challenges. For example, the control problems in telecommunications have their own distinctive characteristics, including different demands on data rate and delay latency (Figure 1). Also, the control is necessarily carried out over the telecommunication channel itself, giving rise to networked control issues.

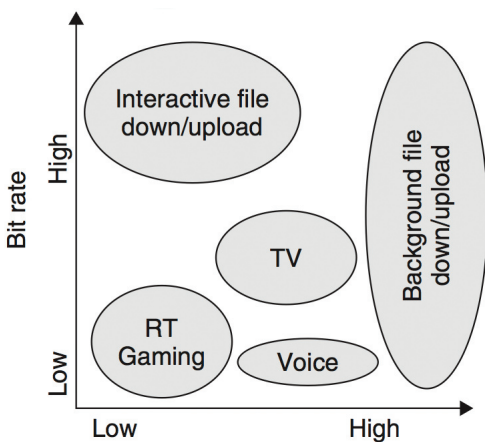

Figure 1: Bit rate/delay issues for mobile services

Control in Telecommunications

Control appears at various levels in mobile telecommunications (Figure 2):

Inner-loop power control: Used to adjust the signal-to-interference ratios of users so that they are maintained at an appropriate level at the base station. This loop operates at 1500 Hz and is quantized to 1 bit with delays of several samples.

Outer-loop power control: Used to adjust the signal-to-interference target so that the block error rate reaches a desired value. This loop operates at a slower rate (approximately 40 ms).

Scheduling: 3G and 4G systems allow for high uplink (between user and base station) data rates, which is achieved by giving users the opportunity to use increased transmit power. This loop operates at a relatively slow rate (2 to 10 ms with delays to 40 ms). There is also a scheduler in the downlink.

Future systems: More complex control problems will arise in future systems, such as multicarrier scheduling for LTE and advanced scheduling in cognitive radio. In the latter case, uncertainty is expected to become even more significant as spectrum availability will also be uncertain.

Telecommunications in Control

Not only is control central to modern mobile telecommunication systems, the reverse is also true; that is, the next-generation control systems are likely to be wireless-based due to flexible connectivity and reduced costs.

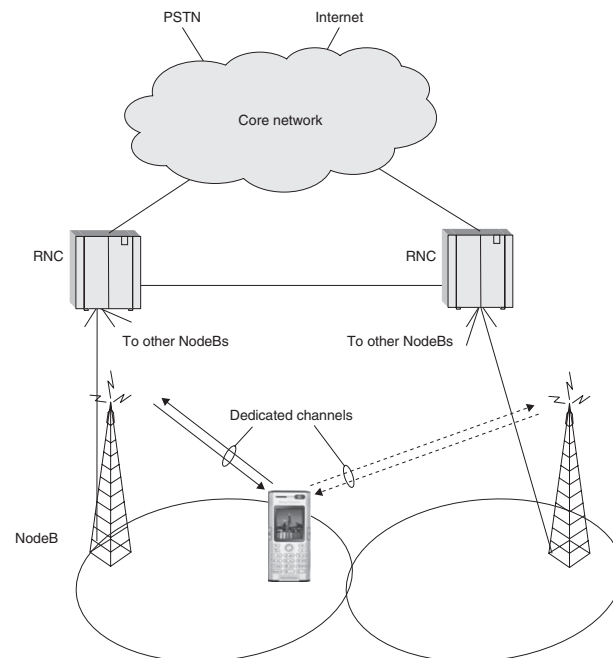

Figure 2: Typical 3G topology

Challenges

Some of the many challenges associated with these telecommunication control problems include:

Inner power control loop

- Heavily quantized control (1 bit)
- Delays
- Lost control signals
- Highly variable channel fading
- Significant nonlinearities
- Multivariable interactions (each user is an interference source on every other user)
- Decentralized information pattern

Scheduling

- Large and variable delays
- High uncertainty in channel gains
- Unused grants (users may already be at maximum power or may have exhausted their data)
- Interactions with neighboring cells (a neighboring cell can issue a "relative grant" to tell a user to turn down its power; this is not known by the "serving cell")

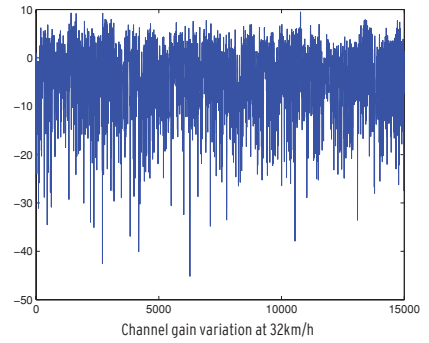
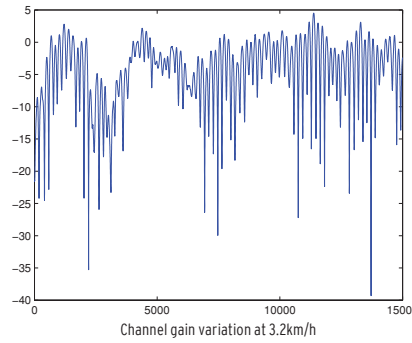
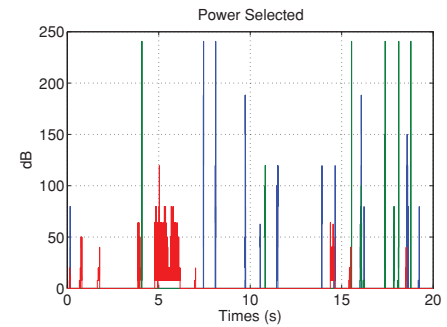
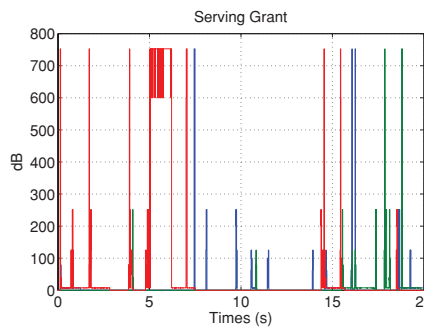
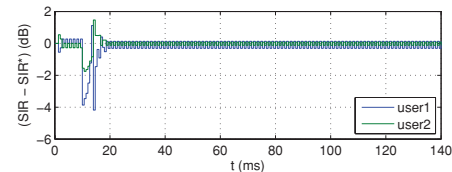
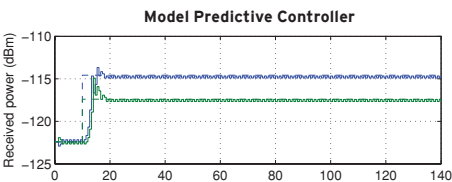
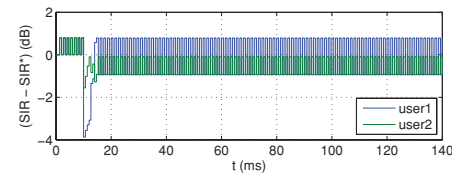
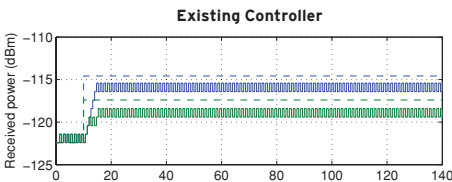

Illustration of fading at different user speeds



Simulation of allocated grants (serving grants) and used grants (selected power)

Opportunities for Advanced Control



Improved inner-loop power control achieved via use of model predictive control

The control challenges in telecommunications suggest that gains can be achieved using sophisticated control tools. However, the application of these tools in the telecommunications context raises new, and as yet unsolved, challenges.

- New ideas in networked control are needed for the inner power loop. This is challenging because only 1 bit can be sent per sample and bits can be lost.
- New scheduling algorithms are needed that exploit the dynamics and inherent constraints of the scheduling loop. High (stochastic) uncertainty, variable delays, high complexity (up to 50 potential users), and short sampling periods (40 ms) make this extremely challenging.
- Novel implementations of nonlinear filtering could be applied to load estimation and for prediction of channel fading, grant utilization, and intercell interference. Here the challenge is due to high state dimension, severe nonlinearities, and fast sampling rates.
- New insights into decentralized control are needed to implement the solution. The stochastic nature of the problem and high demands on quality of service for users are what make this challenging.

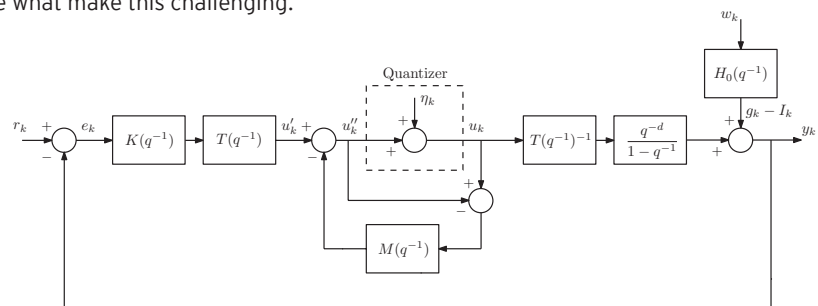

Three-degree-of-freedom inner power control loop